

**1 PLANTA - CASA DE APOIO**  
1 : 50

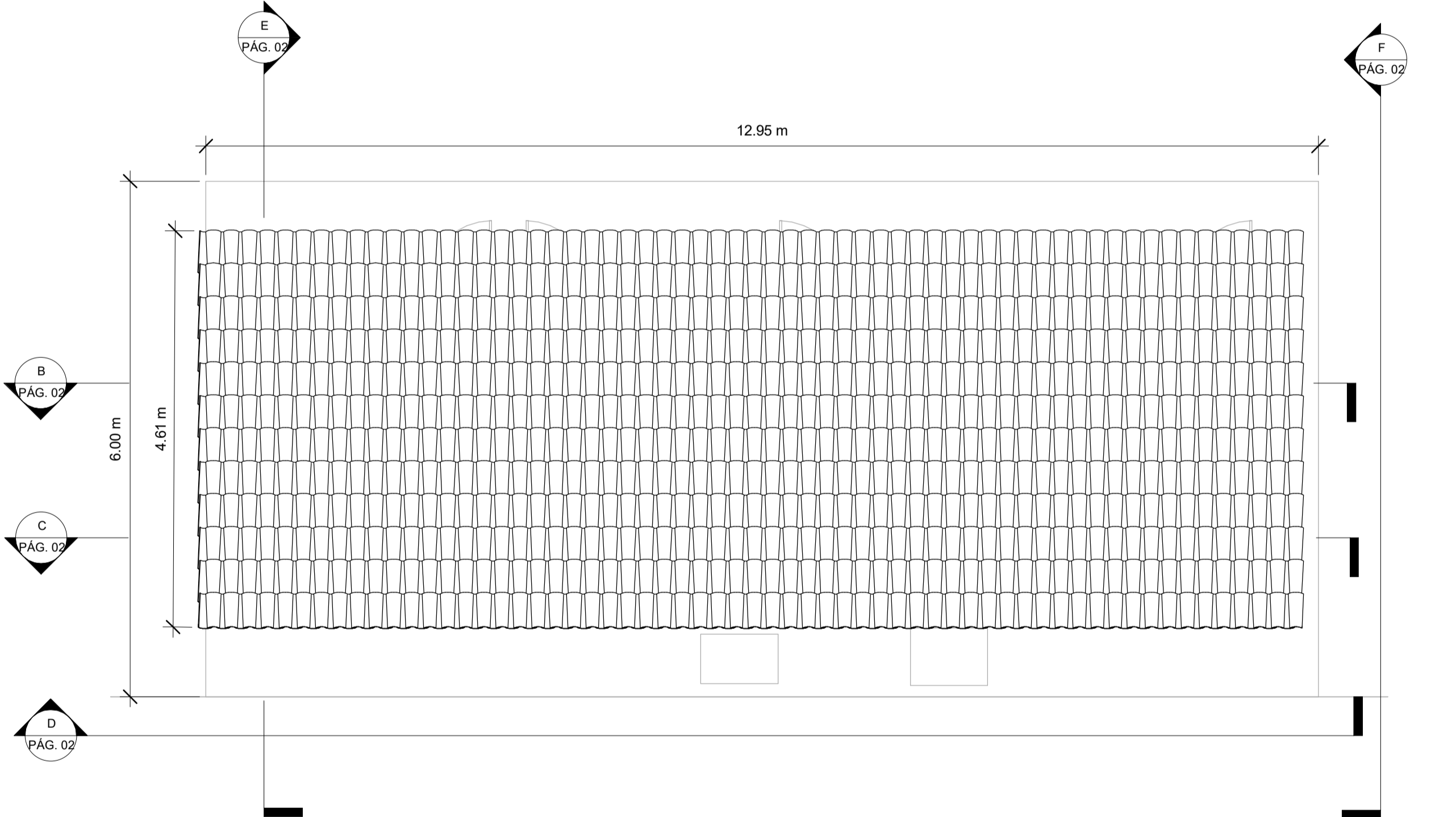

**2 PLANTA - TELHADO**  
1 : 50

Tabela de janela			
ITEM	ALTURA	LARGURA	QTD
J1	0.80 m	0.80 m	2
J2	1.20 m	1.50 m	3

Tabela de porta			
ITEM	ALTURA	LARGURA	QTD
P1	2.10 m	0.80 m	4
P2	2.10 m	0.70 m	1

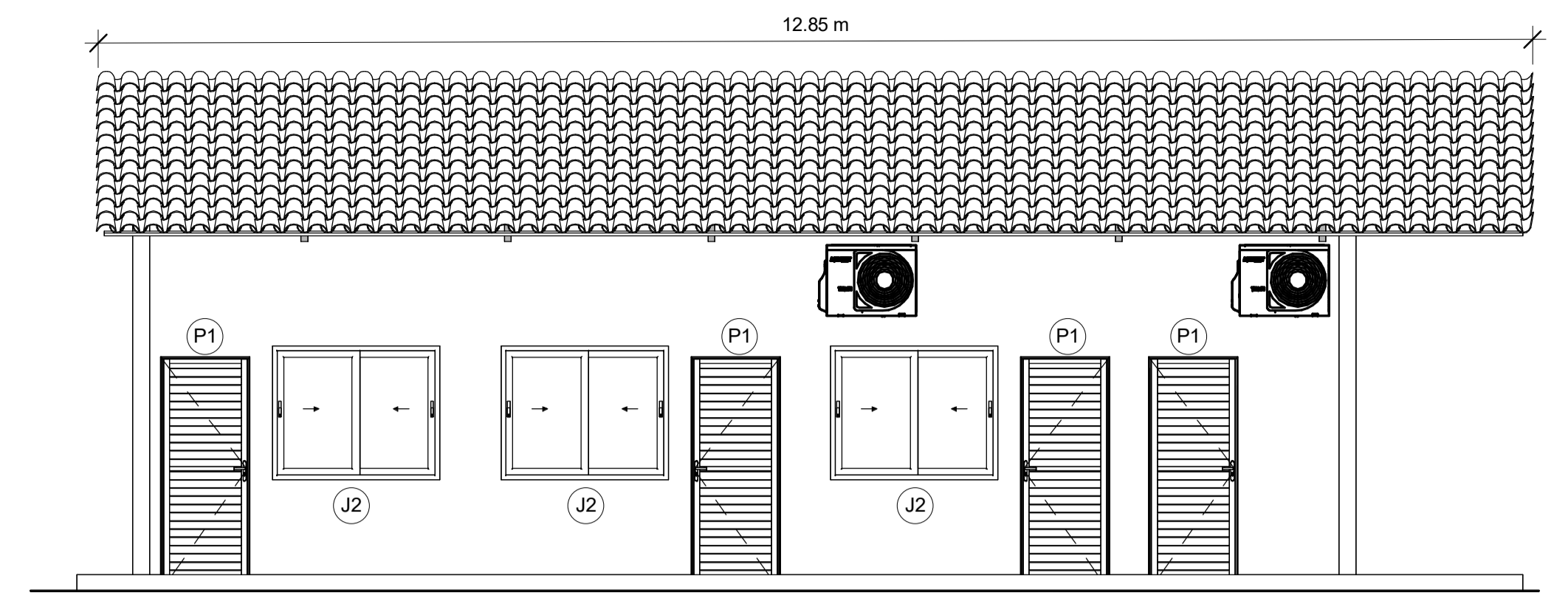

**A CORTE FACHADA DA CASA DE APOIO**  
1 : 50

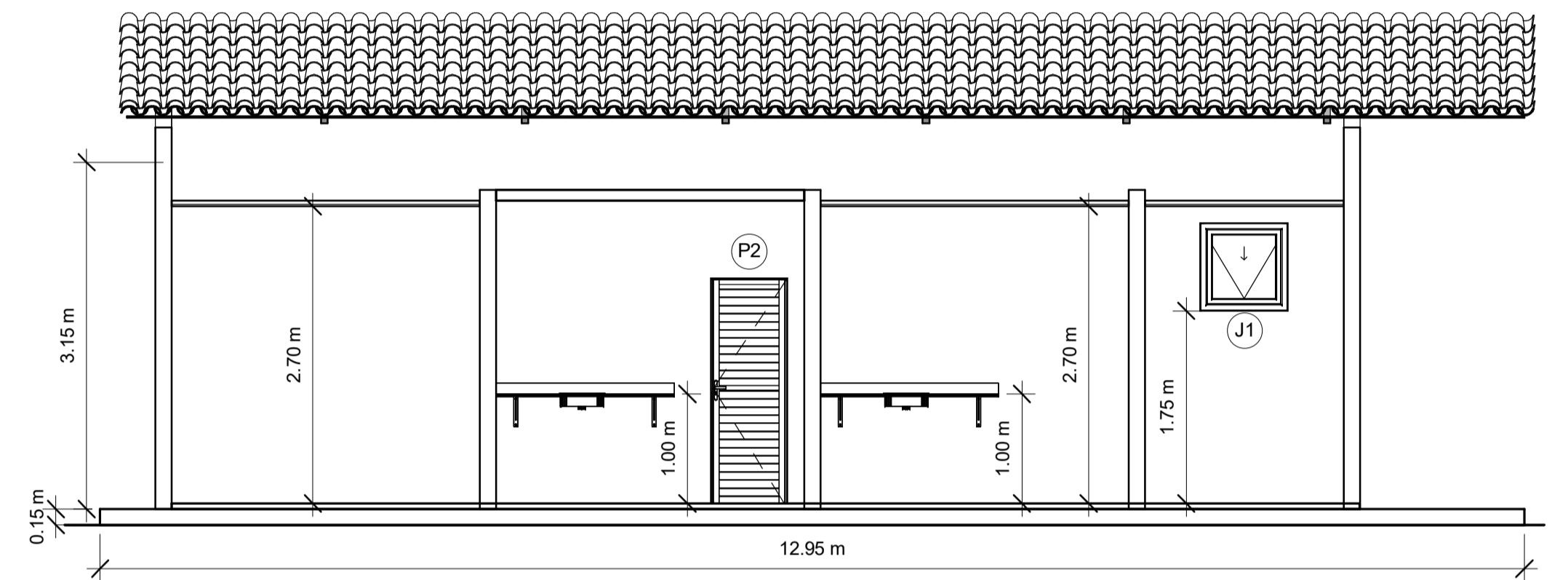

**B Corte AA**  
1 : 50

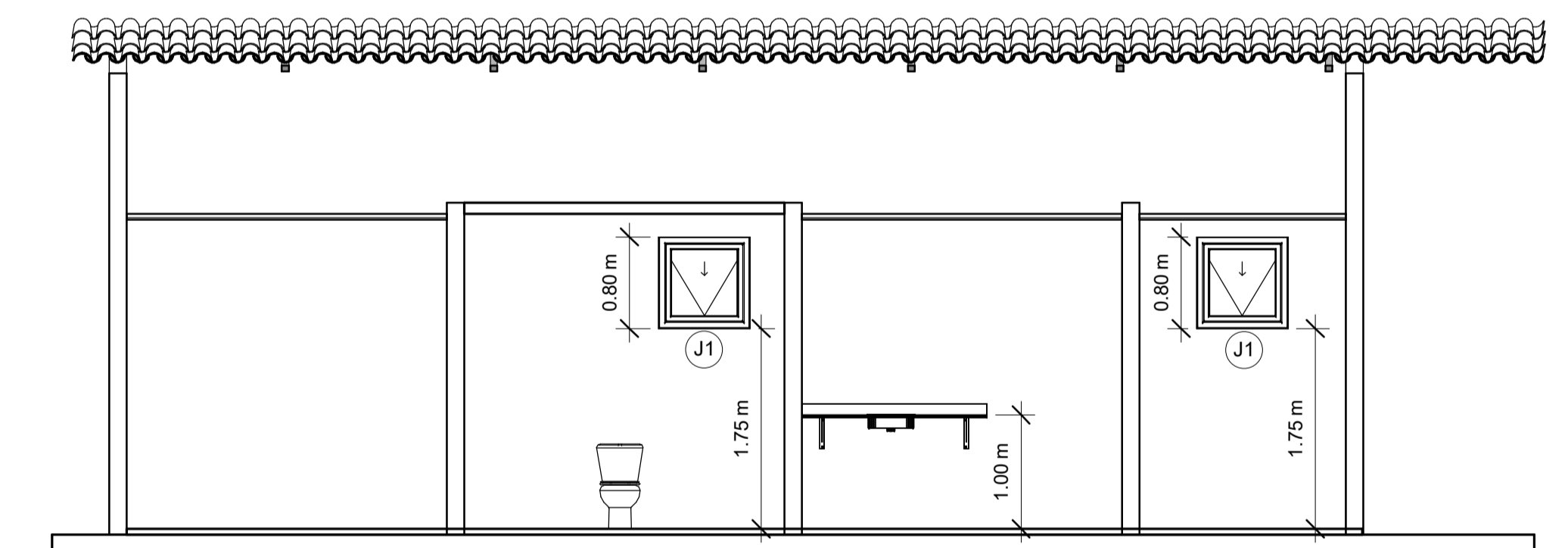

**C Corte BB**  
1 : 50

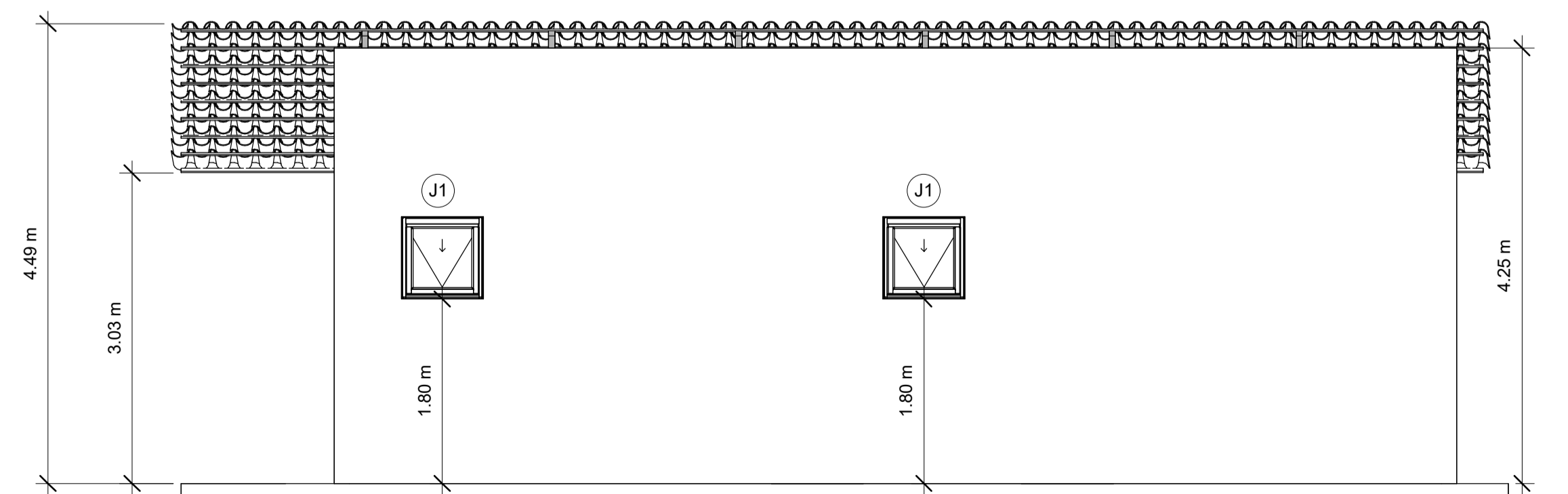

**D VISTA POSTERIOR DA CASA DE APOIO**  
1 : 50

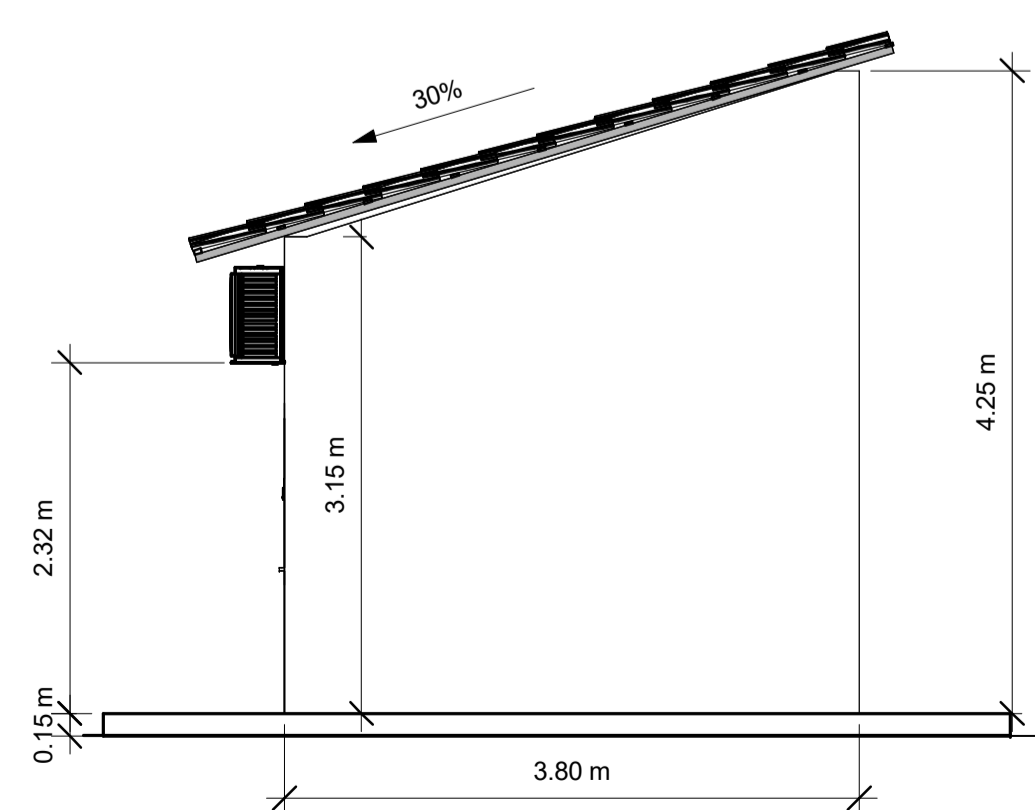

**E VISTA LATERAL DIREITA**  
1 : 50

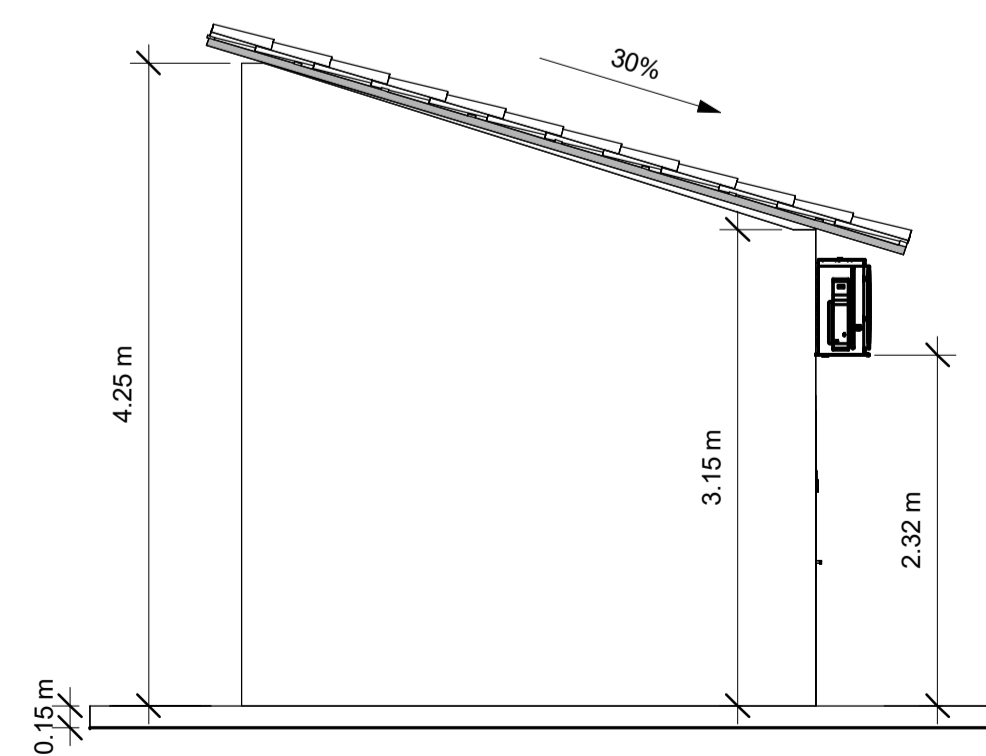

**F VISTA LATERAL ESQUERDA**  
1 : 50

PROJETO	PROJETO
ARQUITETO	PROJETO
PROJETO	PROJETO
PROJETO	PROJETO
PROJETO	PROJETO
PROJETO	PROJETO
PROJETO	PROJETO
PROJETO	PROJETO
PROJETO	PROJETO
PROJETO	PROJETO